

SWANN ROCKER SWITCHES

Please note: This catalogue is primarily a listing of all the common Swann replacement products. **Globelink is the sole NZ agent for Swann** and there are many items not listed that are available for OEM quantities. These include new series & styles now being manufactured by Swann. OEM quantities generally start at 500. Where feasible, Globelink will stock any new replacement manufacturers' spares.

REF: SPDT/DPDT

WHERE A PARTICULAR SWITCH IS MANUFACTURED IN BOTH OF THESE CIRCUITS, WE STOCK THE ON/ON VERSION. THESE CAN BE USED FOR EITHER ON/OFF OR ON/ON APPLICATIONS.

SWANN SPECS:

DIELECTRIC STRENGTH	3500V
INSULATION RESISTANCE	50 MEG-OHMS
MECHANICAL LIFE	100,000 OPERATIONS
LIFE AT FULL LOAD	20,000 OPERATIONS
CONTACT BREAKDOWN	2000V FOR 1 MINUTE
INRUSH CURRENT	70 AMPS

Switching Current:

INDUCTIVE	4 AMPS @ 250VAC
RESISTIVE	16 AMPS @ 250VAC

MATERIALS:

Body	Nylon 6.6 flame retarded ul94-v2
Rocker	Polycarbonate or nylon 6.6
Terminals	Copper/silver UL or CSA copper/tin VDE Min 6 microns plated

APPROVALS:

<i>UNDERWRITERS LABORATORIES</i>	<i>UL</i>
<i>CANADIAN STANDARDS ASSOC.</i>	<i>CSA</i>
<i>FRANCE</i>	<i>VDE</i>
<i>AUSTRALIA</i>	<i>BEAB & SECV</i>
<i>EUROPEAN</i>	<i>KEMA KEUR</i>







Fax us a picture & description - or simply send us your switch if necessary & we will endeavor to advise a suitable replacement from stock. Quantity orders can be indented.

SWANN Rocker Switch & Indicator Listing July 2012

CODE	SERIES (CUT- OUT)	POSITIONS	SWITCHING	BODY COLOUR	ROCKER NON-ILLUM LEVER/BUTT	ROCKER ILLUM
EA102	20	2 POS	DPST	WHITE	WHITE	
S23.02	23	2 POS	SPST	BLACK		RED
S23.04	23	2 POS	SPDT	BLACK	BLACK	
EA103	40	2 POS	SPDT	BLACK	BLACK	
EA104	40	2 POS	SPDT	BLACK	WHITE	
EA105	40	2 POS	SPDT	WHITE	WHITE	
EA106	40	3 POS	SPDT	BLACK	BLACK	
EA107	40	MOM-ON	SPDT	WHITE	WHITE	
EA107B	40	MOM-ON	SPST	BLACK	BLACK	
EA109	50	2 POS	DPDT	BLACK	BLACK	
EA110A	53	2 POS	DPST	BLACK	BLACK	
EA111	70	2 POS	SPDT	BLACK	BLACK	
EA111A	70	3 POS	SPDT	BLACK	BLACK	
EA111M	70	MOM-ON	SPST	BLACK	BLACK	
EA115	82	3 POS	DPDT	BLACK	BLACK	
EA115A	82	2 POS	DPDT	BLACK	BLACK	
EA116	475	2 POS	SPDT	BLACK	BLACK	
EA116A	475	3 POS	SPDT	BLACK	BLACK	
EA202	41	2 POS	SPST	BLACK		RED
EA205	50	2 POS	DPDT	BLACK		AMBER
EA206	50	2 POS	DPDT	BLACK		RED
EA207	50	2 POS	DPDT	WHITE		AMBER
EA208	50	2 POS	DPDT	WHITE		RED
EA213	50	3 POS	DPDT	BLACK		
EA210	82	3 POS	DPDT	BLACK		RED
EA210A	82	2 POS	DPDT	BLACK		AMBER
EA210R	82	2 POS	DPDT	BLACK		RED
EA240	73	3 POS	DPDT	BLACK		RED
EA301	9000	ROUND	IND.LEADS	BLACK		AMBER
EA302	9000	SM RED BEZEL	IND.LEADS	BLACK		RED
EA305	9000	ROUND	IND.LEADS	BLACK		RED
EA307	9000	ROUND	IND.SNAP-IN	BLACK		AMBER
EA308	9000	ROUND	IND.SNAP-IN	BLACK		RED
EA312	50	S50 CUT-OUT	INDICATOR	BLACK		RED
EA312/GREEN	50	S50 CUT-OUT	INDICATOR	BLACK		GREEN
EA412	40	S40 CUT-OUT	INDICATOR	BLACK		RED
EA313	1200	ROUND	IND.SNAP-IN	BLACK		RED
EA314	1200	ROUND	IND.SNAP-IN	BLACK		AMBER
EA316	1200	ROUND	IND.SNAP-IN	BLACK		GREEN
91201	51	DPDT	DPST	BLACK		RED

SWANN ROCKER SWITCHES

Series 53-82

<p>20 Series 240V 4A Single Pole Fits 16 x 13mm hole Solder Terminals</p> <p>EA102 On/On White</p> <p>Only available with terminals as shown (n/a screw terms)</p> 	<p>23 Series 240V 6A Single Pole 19.4 x 13.2mm hole 4.8mm QC terminals</p> <p>S23.02 On/Off Red illum S23.04 On/On Black <i>ALL Series 23 switches are <u>NOT</u> packaged in EA packs</i></p> 	<p>40 Series 240V 15A Single Pole 27.4 x 12.3mm hole 6.3mm QC terminals</p> <p>EA103 On/On Black EA104 On/On Blk body, wh/rkr EA105 On/On White Rocker EA106 On/Off/On Black EA107 On/Mom.On EA107B On/Mom.On</p> 
<p>41 Series 240V 15A Single Pole 28.5 x 11.5mm hole 6.3mm QC terminals</p> <p>EA202 On/Off Black -red illuminated</p> 	<p>50 Series 240V 15A Double Pole 27.2 x 22.2mm hole 6.3mm QC terminals</p> <p>EA109 On/On Black EA205 On/On Black - Amber illuminated EA206 On/On Black - Red illuminated EA207 On/On White - Red Illuminated EA208 On/On White Amber Illuminated EA213 On/Off/On Black</p> <p>Note: Series 50 N/A White</p> 	<p>51 Series 240v 15A Double Pole 28.5 x 22.2mm hole 6.3mm QC terminals</p> <p>91201 On/On Black -red illuminated (use F&P Part # 91201) Packaged.</p> 

SWANN COMELUX ROCKERS

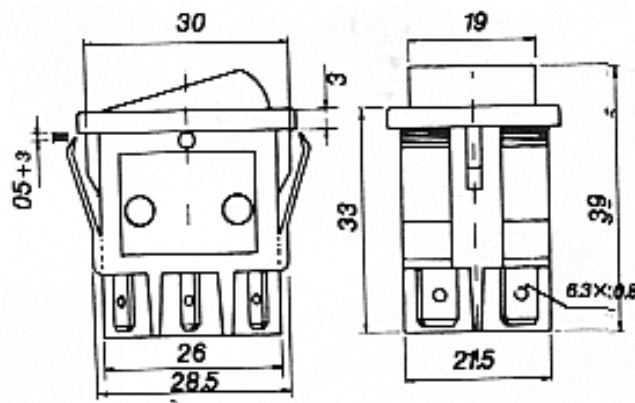

MD401/START

(Closest replacement for Swann EA211: Approx 2mm variance in length)

- ◆ White body, amber illum.
- ◆ Dpst on-mom-on
- ◆ Push to start
- ◆ Hot stamped start vertically
- ◆ down rocker as shown
- ◆ 16a 240vac
- ◆ Temp rating: 100 deg c
- ◆ Silver plated brass terminals
- ◆ Silver contacts



MD36L2R

- ◆ 16a/240vac snap-in rocker
- ◆ Black body, Red Illuminated
- ◆ On-off spst x 2
- ◆ Temp rating: 120 degc.
- ◆ Silver plated brass terminals (.250mm)
- ◆ Silver contacts



MD401/L

- ◆ Water & dust resistant
- ◆ Transparent natural clear plastic protecting cap
- ◆ Black body, red illuminated
- ◆ DPST on/off
- ◆ 16Amp, 240vac
- ◆ Temp rating: 100 deg c
- ◆ Silver plated brass terminals
- ◆ Silver contacts

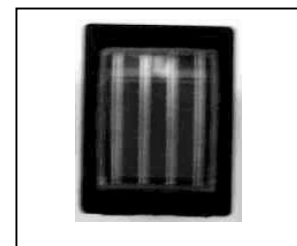

General information on the Swann rocker switch selection

- In general - no two brands of switches are identical - in fact switch manufacturers protect their market by specifying designs and cut-out sizes that are unique to their brand. However, some switches though not identical, will fit the same cut-out size.
- The **Swann 40 Series** Switches fit the same cut-out as the **Eaton 1600 Series** Rockers & Indicators.
- The **1606-11E** (10amp SPDT) is the **ONLY** Rocker available ex-stock that is **On>Off<On**. For varying circuits other than SPDT, we can only offer a toggle switch (see page 2).
- The **Swann 50 Series** Switches fit the same cut-out as the **Eaton 2600 Series** Rockers & Indicators

SWANN TOGGLES Series 475

SERIES 475

Wedge Lever

240V 10A Single Pole

6.3mm QC terminals

EA116: On/On

EA116A: On/Off/On



240V AC NEONS Series 9000 & 1200

<p>Swann Series 9000 Fits 9.3mm hole 6.3mm QC terminals - 240V <i>10mm dia.. head</i></p> <p>EA308 - Red EA307 - Amber</p> 	<p>Swann Series 9000 Fits 9.3mm diameter. hole Coated wire leads - 240V <i>Round head, 152mm leads</i> <i>(Not available in Green)</i></p> <p>EA305 - Red EA301 - Amber</p> 	<p>Swann Ned Kelly 240V Indicator with leads EA302 Rectangular red bezel</p> 
<p>Swann Series 1200 Fits 12.3mm dia. hole 6.3mm QC terminals - 240V <i>Round Head</i></p> <p>EA313 - Red EA314 - Amber EA316 - Green</p> 	<p>Swann 40 Series 240V - Fits 27.5 x 12.2mm hole – (same cut-out as series 40 rockers) Black Body. 6.3mm QC terminals</p> <p>EA412 - Red</p> 	<p>Swann 50 Series 240V Fits 27.2 x 22.2mm hole .Black body 6.3mm QC terms.</p> <p>EA312 - Red EA312/GREEN - Green</p> 